

### Features:

- Universal AC input / Full range
- Installed on DIN rail TS-35 / 7.5 or 15
- Built-in active PFC function, PF > 0.95
- 150% peak load capability
- Protection: SCP, OLP, OVP, OTP
- Two selectable peak load modes
- Built-in DC OK Relay contact
- Built-in Remote ON / OFF function
- 3 years warranty



MODEL		DV-240-24	DV-240-48
Output	DC Voltage Range	24V	48V
	Rated Current	10A	5A
	Current Range	0 ~ 10A	0 ~ 5A
	Rated Power	240W	240W
	Peak Current	15A	7.5A
	Peak Power	Note.6 360W (3sec.) Two selectable peak load modes	
	Ripple & Noise (Max.)	Note.2 240mVp-p	480mVp-p
	Voltage Adjustment Range	-2 ~ +8%	-2 ~ +8%
	Voltage Tolerance	Note.3 ±1.0%	±1.0%
	Line Regulation	±0.5%	±0.5%
	Load Regulation	±1.0%	±1.0%
	Setup, Rise Time	700ms, 30ms / 230VAC / 115VAC at full load	
Hold Time (Typ.)	20ms / 230VAC, 20ms / 115VAC at full load		
Input	Voltage Range	90 ~ 264VAC, 124 ~ 373VDC	
	Frequency Range	47 ~ 63Hz	
	Power Factor (Typ.)	0.96 / 230VAC / 115VAC at full load	
	Efficiency (Typ.)	91%	92%
	AC Current (Typ.)	2.6A / 115VAC, 1.3A / 230VAC	
	Inrush Current (Typ.)	33A / 115VAC, 65A / 230VAC	
	Leakage Current	< 1mA / 240VAC	
Protection	Over Load	Hiccup mode: when the rated output power is within 105 ~ 150% for more than 3secs. Constant current limit: > 150% rated power / short circuit Auto-recovery: If O/P drop to 40% of the rated output voltage, PSU will shut down and auto-recover 5times (If fault condition remains after 5times recovery, PSU will shut down. User must re-power on to recover)	
	Over Voltage	28 ~ 33V	56 ~ 65V
		Protection type: Latch-off mode	
	Over Temperature	95 ±5°C (TSW: detect on heatsink of power diode) Protection type: Shut down o/p voltage, recovers automatically after temperature goes down	
	DC OK Relay Contact Ratings (Max.)	60VDC / 0.3A, 30VDC / 1A, 30VAC / 0.5A resistive load	
Environment	Working Temp.	Note.5 -25 ~ +70°C (Refer to de-rating curve)	
	Working Humidity	20 ~ 95% RH non-condensing	
	Storage Temp. & Humidity	-40 ~ +85°C, 10 ~ 95% RH	
	Temp. Coefficient	±0.03% / °C (0 ~ 50°C)	
	Vibration	Component: 10 ~ 500Hz, 2G 10min. / 1cycle, 60min. each along X, Y, Z axes; Mounting: Certified IEC 60068-2-6	
Safety & EMC	Safety Standards	Certified UL 508 / EN 60950-1	
	Withstand Voltage	I/P-O/P: 4242VDC, I/P-FG: 2121VDC, O/P-FG: 707VDC, O/P-DC OK: 707VDC	
	Isolation Resistance	I/P-O/P, I/P-FG, O/P-FG: >100M Ohms / 500VDC / 25°C / 70% RH	
	EMI Conduction & Radiation	Certified EN 55022	
	Harmonic Current	Certified EN 61000-3-2; EN 61000-3-3; EN 61000-6-3	
EMS Immunity	Certified EN 61204-3; EN 55024; Meet SEMI F47; EN 61000-6-1, IEC 61000-4-2, 3, 4, 5, 6, 8, 11		
Others	MTBF	56.867K HRS Certified MIL-HDBK-217F (25°C)	
	Dimension (WxHxD)	65.8x125.2x117.75 mm / 2.591x4.929x4.636 inch	
	Packing	1.0kg; 12pcs / 13kg / 1.32CUFT	
Note	<p>1. All parameters NOT specially mentioned are measured at 230VAC input, rated load and 25°C of ambient temperature.</p> <p>2. Ripple &amp; noise are measured at 20MHz of bandwidth by using a 12" twisted pair-wire terminated with a 0.1uF &amp; 47uF parallel capacitor.</p> <p>3. Tolerance: includes setup time tolerance, line regulation and load regulation.</p> <p>4. The power supply is considered a component which will be installed into a final equipment. The final equipment must be re-confirmed that it still meets EMC directives.</p> <p>5. Installation clearance: 40mm from top, 20mm from bottom, 5mm from the left and right sides are recommended when loaded permanently with full power. In case the adjacent device is a heat source, 15mm clearance is recommended.</p> <p>6. 3 seconds or 20% duty cycle Max. The average output power should not exceed the rated power.</p> <p>7. De-rating may apply in low input voltage. Please check the de-rating curve for more details.</p>		

### Mechanical Drawings:

Unit : mm / inch

Terminal Pin No. Assignment (TB1)

Pin NO.	Assignment
1	FG ⊕
2	AC/L
3	AC/N

Terminal Pin No. Assignment (TB2)

Pin NO.	Assignment
1	DC+
2	DC-
3	INH+
4	INH-
5,6	Relay Contact

Switch No. Assignment

SW NO.	Assignment
SW1	PEAK LOAD SETTING
SW2	REMOTE ON/OFF SETTING

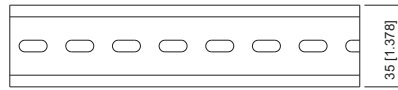
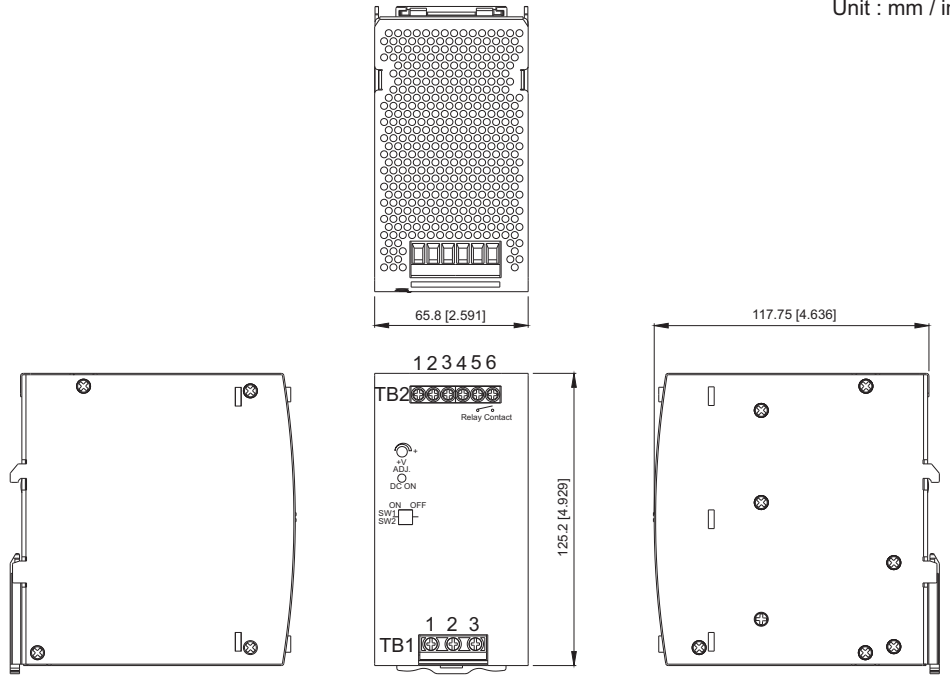

Admissible DIN-RAIL:  
TS-35/7.5 OR TS-35/15

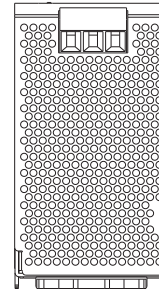

### Block Diagram:

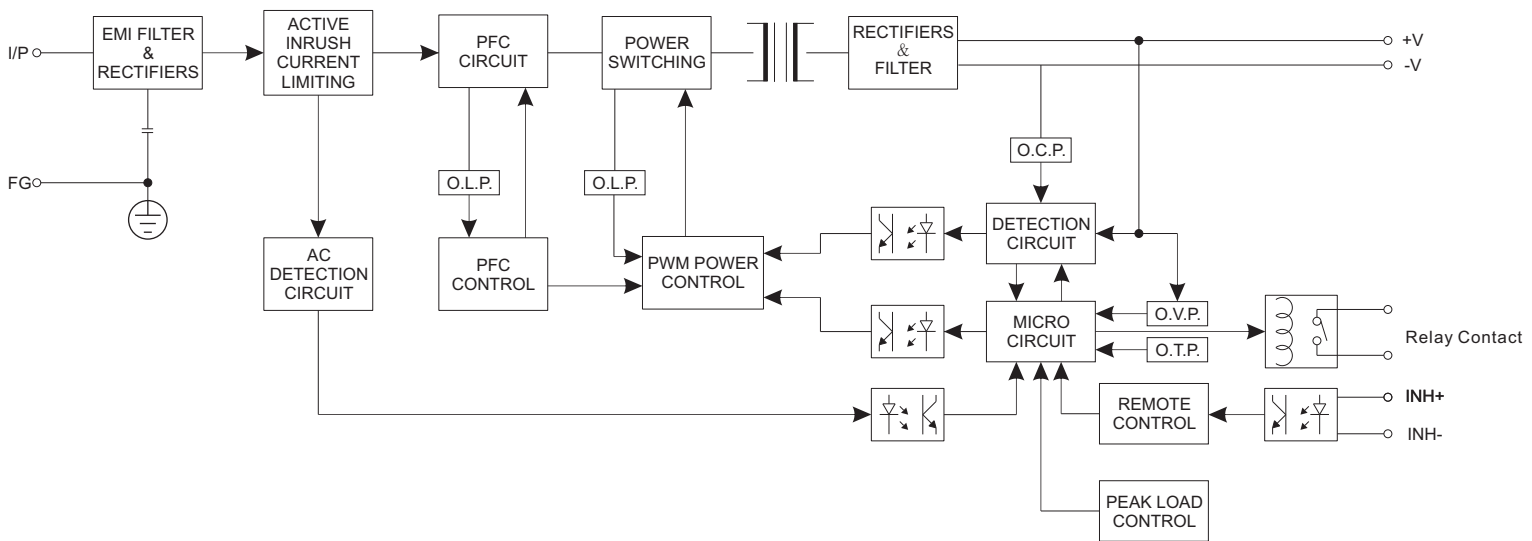

### DC OK Relay Contact:

Contact Close	When the output voltage reaches the adjusted output voltage.
Contact Open	When the output voltage drop below 45% rated output voltage.
Contact Ratings(max.)	30V/1A resistive load

**Peak Load SW1 ON (Mode1) Default setting:**

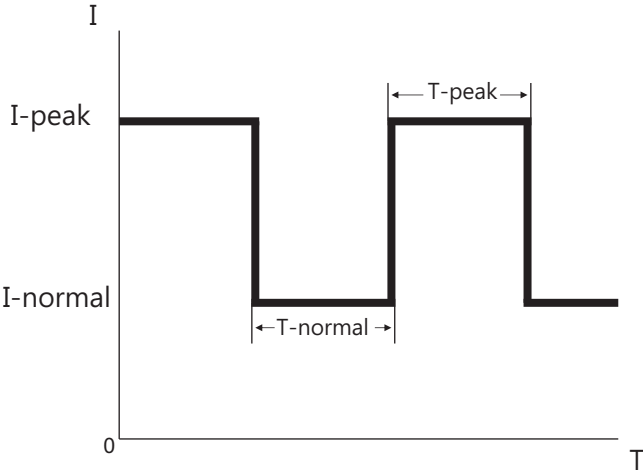

T-peak presents while the unit is working within 110%~150% Rating output power. See curve " B " for the variation in T-peak between output current and holdup time. If T-peak is more than the time setting in curve "B", the output current will drop to the constant current limit (I-normal) that is 105% rating power, meanwhile, I-normal and T-normal will be presenting. See curve "A" for the timing back to I-Peak of T-normal and this Mode can use for easy 2-stage battery charger.

**Peak Load SW1 OFF (Mode2):**

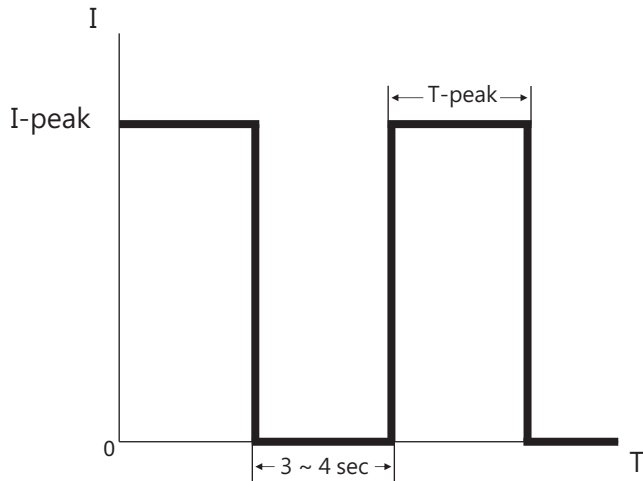

T-peak presents while the unit is working within 110%~150% Rating output power. See curve " B " for the variation in T-peak between output current and holdup time. If T-peak is more than the time setting in curve "B", the output voltage will be shut down for 3~4 sec, then auto-recovery.

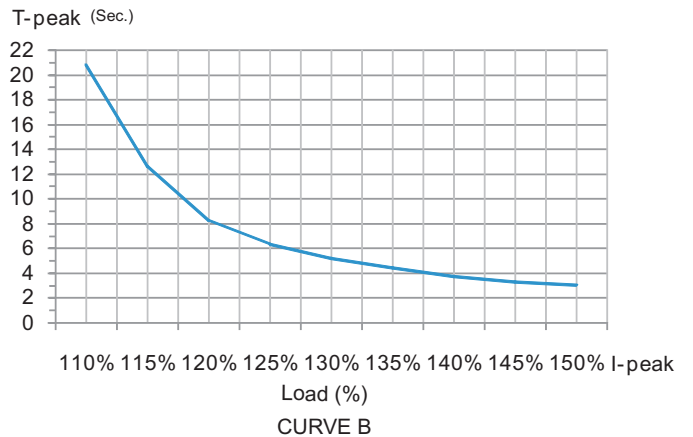
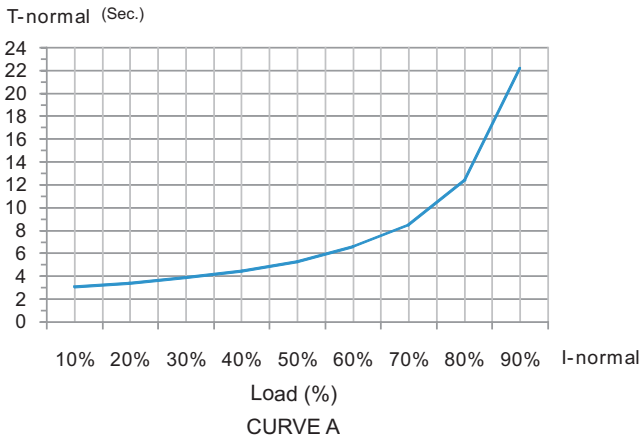

### Remote ON / OFF:

The PSU can be turned ON/OFF by using the "Remote Control" function.

SW2	INH+(3 PIN)/ INH-(4 PIN)	Output Status
OFF	SW ON (>2.5V)	ENABLE
OFF	SW OFF (<0.8V)	DISABLE
ON	SW ON (>2.5V)	DISABLE
ON	SW OFF (<0.8V)	ENABLE

(Default Setting)

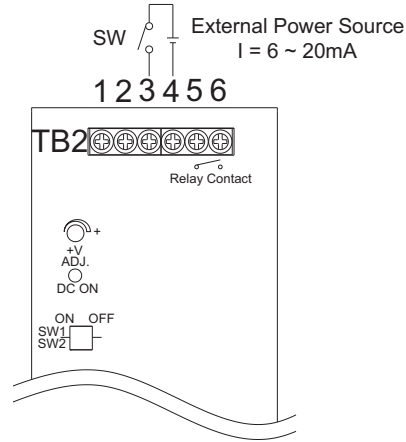

### De-rating Curve:

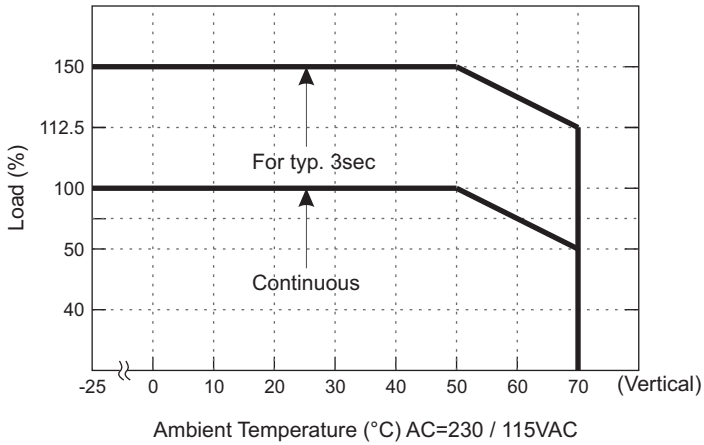

### Output derating VS input voltage:

